

NETWORK ANALYSER

MPR60S / MPR60S-10/20/21/40/41

CORRECT USAGE and SAFETY PRECAUTIONS

- Failure to abide by the precautions below may result in SERIOUS INJURY or DEATH.
- Cut all power before connecting the device.
 - Once the device is online on the network, do not remove the front panel.
 - Do not attempt to clean the device with a solvent or another similar agent.
 - Only a dry piece of cloth is used..
 - Check the connections.
 - Electrical devices should be repaired only by your authorized seller.
 - The device is for panel type installation only.
 - The fuse used must be Type FF and the current limit value should be 1A.
 - The production company or the authorized seller is not responsible for the consequences resulting from failure to comply with these precautions.

Warning :

- A switch or circuit breaker must be connected between the network and the auxiliary supply input of device.
- Connected switch or circuit breaker must be in close proximity to the device.
- Connected switch or circuit breaker must be marked as the disconnecting device for the equipment.

Standards which are applied to the device:

EN 61000-6-2, EN 61000-6-4, EN 55016-2-1, EN 55016-2-3, EN 55011, EN 61000-3-2, EN 61000-3-3, EN 61010-1, EN 61000-4-2, EN 61000-4-3, EN 61000-4-4, EN 61000-4-5, EN 61000-4-6, EN 61000-4-8, EN 61000-4-11

GENERAL INFORMATION

Device, based on DSP (Digital Signal Processor), is designed for the purpose of measuring all parameters in industry plants and recording these parameters to its memory. The measured parameters can be displayed on LCD screen which has dimension of 3.6 inch and can be read easily in dark environments by activating the Back-Light function. Device contains a MODBUS serial interface option.

FEATURES

- Measurements of parameters given in the parameter table can be displayed on LCD screen.
- Current and voltage transformer ratios can be programmed.
- Parameters in 3 phase with neutral, 3 phase without neutral and Aron connection systems can be measured
- Data communication with PC can be provided by using RS-485 outputs
- Selected parameters can be recorded onto memory with date and time.
- Recorded parameters can be transferred to a PC through the software.
- It can assign 3 parameters each to the 1. Relay 1 and 2. Relay 2. If the parameter values are not within the adjusted limits, the output relay can be made to change contact (These outputs can be used for the purpose of alarm warnings).
- The existence of 3 phases can be displayed as "VL1 Φ ,VL2 Φ ,VL3 Φ " on the right corner of the device at any time.
- The values of the current and voltage total harmonics (THD) can be observed on the left side of the screen.
- Outputs can be observed on the LCD screen to see which ones are active.
- Unauthorized access to the device's settings can be prevented by setting up a password from the Setup Menu.

DIMENSIONS

Panel Cut Dimensions

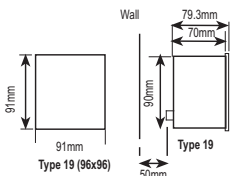

- The device fits into a Type 19 square cut out (91 mm x 91 mm).
- Remove the thumbscrews, then slide out the securing brackets from the rear panel.
- Place the device through the panel cut-out, then slide the securing brackets back into the slots on each side of the device.
- Tighten the thumbscrews so that the securing brackets bear on the rear of the panel into which the device has been placed.
- The current and voltage connectors are designed for cables up to 2.5 mm², but can accept cables up to 4 mm²
- Category 5 cable is suggested for RS-485 input connector

Excessive force can damage the device. The thumbscrews only need to be "finger-tight" to hold the device in place.

Note: For 3 phase with neutral connection (Figure1) the neutral must be connected; otherwise the device will not function.

INSTALLATION DIAGRAM

Important note for making system connection;

First, connect the supply and voltage measurement inputs. Apply energy and measurement voltage to the device. Observe the existence of three phases from LCD screen. Φ Φ Φ indicators must be seen.

If Δ indicator (phase sequence is not correct) is seen in addition to these indicators, cut the energy and measurement voltage and change the direction of 2 phases. At next step, you can connect current and another connections as mentioned in the installation diagram.

* This box consists of 1 User Manual CD, 1 Installation Guide, 2 clamps and 2 screwed clamps.

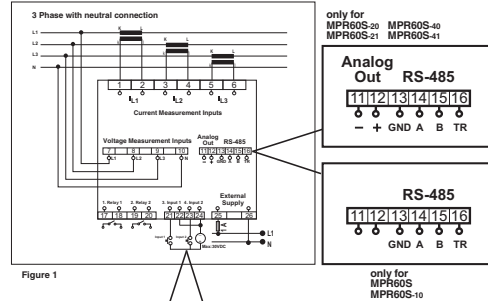

Figure 1

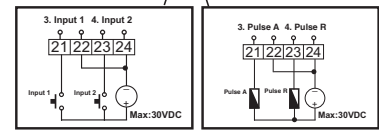

Figure 2

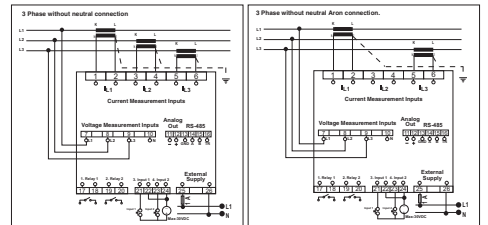
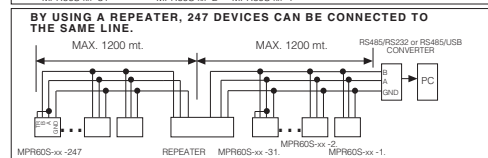
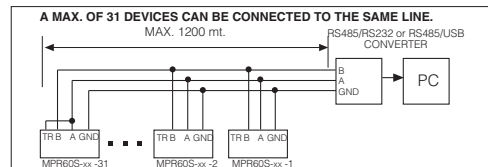

Figure 2

Figure 3

PC CONNECTION



NETWORK ANALYSER

MPR60S / MPR60S-10/20/21/40/41

SETUP

Setting up Device on the Network and Configuring its Settings:

After connecting the device as mentioned in the user's manual, supply energy. In order for your measurement and applications to be correct, make the necessary configurations in the SETUP menu.

"SETUP" To enter to the "SETUP" menu, while in the Instantaneous Values menu;

Press the ENTER button. (The ENERGY menu is displayed)



Find the "SETUP" menu by scrolling using the UP/DOWN buttons.

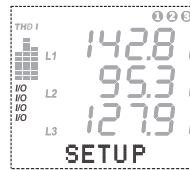

The image of screen is at side while in this menu

Sub-menus under the SETUP menu and what these sub-menu settings can be used for are explained in detail below.

NETWORK

In this menu, current transformer ratio, voltage transformer ratio and system connection type of device are set.

It has 5 sub-menu.

"CT:.....", "VT:.....", "Net:.....", "Eng:.....", "E.Unit:....."

CT: (Current transformer ratio) :

The current transformer ratio is set in this menu. It can be programmed between 1...5000

"CT" To set the "CT" ratio, while in the Instantaneous Values menu;

Press the ENTER button. (ENERGY is displayed)



Find the "SETUP" menu by scrolling using the UP/DOWN buttons.

Press the ENTER button. (The Network menu is displayed)



Press the ENTER button. (CT is displayed)

Press the ENTER button

Enter the appropriate "CT" ratio (between 1...5000) by scrolling using the UP/DOWN buttons.

To record the new "CT" value, press ENTER button.

VT: (Voltage transformer ratio):

The voltage transformer ratio can be programmed between 1,0...4000,0 Transformer ratio can set in 0,1 step. Please pay attention that voltage transformer ratio is entered directly instead of primary voltage value.

"VT" To set the "VT" voltage transformer ratio; While in Instantaneous Values menu;

Press the ENTER button. (The ENERGY menu is displayed)



Find the "SETUP" menu by scrolling using the UP/DOWN buttons.

Press the ENTER button. (The Network menu is displayed)

Press the ENTER button. (CT is displayed)

Find the "VT" Menu by scrolling using the UP/DOWN buttons.

Press the ENTER button.



Enter a "VT" value (between 1,0...4000,0) by scrolling using the UP/DOWN buttons.

To record the "VT" value, press the ENTER button.

Net: (Type of system connection)

The type of system connection is set in this menu.

"Net" To set the connection type; while in the Instantaneous Values menu;

Press the ENTER button. (The ENERGY menu is displayed)



Find the "SETUP" menu by scrolling using the UP/DOWN buttons.

Press the ENTER button.(The Network menu is displayed)

Press the ENTER button.(The CT menu is displayed)



Find the "Net" menu by scrolling using the UP/DOWN buttons.

Press the ENTER button.



Enter the "Net" system connection type by scrolling using the UP/DOWN buttons.(3P4W, ARON, 3P3W)

To record the "Net" system connection type, press the ENTER button.

Note: 3P4W : 3 Phase + Neutral (Star connection)
3P3W : 3 Phase No Neutral(Delta connection)
ARON : ARON connection

Eng: (Energy Calculation)

If "Tot" menu is selected, device measures the reactive powers of three phases. If total phase value is inductive, it records values to the inductive area. If total phase value is capacitive, it records values to the reactive area.

If "Sprt" menu is selected, device measures the reactive powers of three phases for each phase separately. If phase value is in the inductive area, it records values to the inductive reactive area. If phase value is in the capacitive area, it records values to the capacitive reactive area. **Measurement for each phase separately can be done for 3P4W (3 Phase with Neutral) systems.**

E.Unit: (Energy Unit)

It is used for determine the units of energy counters.

Counters can be chosen Mega or Kilo.

for example : If energy counter value is 12345678901 kWh when "k" is chosen, 45678901 kWh will be displayed or when "M" is chosen, 12345678 MWh will be displayed.

DATE

Date:.....(DD/MM/YY)

It records to its memory the measurement value assigned parameters in the Datalog Menu with date and time.For this reason, it is important to set the date and time correctly.

"Date" To set the date, while in the Instantaneous Values menu;

Press the ENTER button. (The ENERGY menu is displayed)



Find the "SETUP" menu by scrolling using the UP/DOWN buttons.

Press the ENTER button. (The Network menu is displayed)



Find the "Date" menu by scrolling using the UP/DOWN buttons.

Press the ENTER button.



Enter the "Date" by scrolling using the UP/DOWN buttons.

To record the "Date", press the ENTER button.

NETWORK ANALYSER

MPR60S / MPR60S-10/20/21/40/41

TIME

Time: (Hour / Minute / Seconds)

"Time" To set the time, while in the Instantaneous Values menu;

- Press the ENTER button. (The ENERGY menu is displayed)
- Find the "SETUP" menu by scrolling using the UP/DOWN buttons.
- Press the ENTER button. (Network menu is displayed)
- Find the "Time" menu by scrolling using the UP/DOWN buttons.
- Press the ENTER button.
- Press the ENTER button.
- Enter the "Time" by scrolling using the UP/DOWN buttons.
- To record the "Time", press the ENTER button.

NOTE: Even if the ENERGY is interrupted, Date and Time informations of device is saved and operated during 72 hours.

RS-485

RS-485 (PC Communication Settings)

Device has a MODBUS RTU communication protocol. Parameters measured by device can be transferred to a PC through the software. Using this software, all settings of device can be configured by means of PC. **It is necessary to set the Baud Rate, Address and Parity values to the device in order to communicate with a PC.**

RS-485 has 3 sub-menus.
"Addr: ...", "Bd: ...", "Prt: ..."

Addr: (Address Information)

"Addr" To enter the address information, while in the Instantaneous Values menu;

- Press the ENTER button. (The ENERGY menu is displayed)
- Find the "SETUP" menu by scrolling using the UP/DOWN buttons.
- Press the ENTER button. (Network menu is displayed)
- Find the "RS-485" menu by scrolling using the UP/DOWN buttons.
- Press the ENTER button. (The Addr menu is displayed)
- Press the ENTER button.
- Enter "Addr" information (1..247) by scrolling using the UP/DOWN buttons.
- To record "Addr" information, press the ENTER button.

Bd : (Baud Rate Value)

"Bd" To set the Bd value, while in the Instantaneous Values menu;

- Press the ENTER button. (The ENERGY menu is displayed)
- Find the "SETUP" menu by scrolling using the UP/DOWN buttons.
- Press the ENTER button. (The Network menu is displayed)
- Find the "RS-485" menu by scrolling using the UP/DOWN buttons.
- Press the ENTER button. (Addr menu is displayed)
- Find the "Bd" Menu by scrolling using the UP/DOWN buttons.
- Press the ENTER button.
- Enter a "Bd" value (1200, 2400, 4800, 9600, 19200, 38400bps) by scrolling using the UP/DOWN buttons.
- To record the "Bd" value, press the ENTER button.

Prt: (Parity Settings)

"Prt" To set the Prt settings, while in the Instantaneous Values menu;

- Press the ENTER button. (The ENERGY menu is displayed)
- Find the "SETUP" menu by scrolling using the UP/DOWN buttons.
- Press the ENTER button. (Network menu is displayed)
- Find the "RS-485" menu by scrolling using the UP/DOWN buttons.
- Press the ENTER button. (Addr menu is displayed)
- Find "Prt" menu by scrolling using the UP/DOWN buttons.
- Press the ENTER button.
- Enter "Prt" settings (None, Odd, Even) by scrolling using the UP/DOWN buttons.
- To record the "Prt" settings press the ENTER button.

DATALOG

Datalog Menu

Device contains memory in order to record desired parameters with date and time. Recorded parameters and the process about recording are set in the Datalog menu. These recordings can also be displayed on a PC screen. The memory is not effected from power cuts.

The "Datalog" menu has 30 sub-menus.

"Pr1:..." "Pr2:..." "Pr28:..." , "Per:..." , "Event:..."

"Pr1: ..." "Pr2: ..." "Pr28:..." (Parameter Menus)

A total of 28 parameters can be assigned to these menus with one parameter per each menu: These parameter values are recorded on to device memory.

The parameters that can be seen in **parameter tables** (See page 4).

If no parameter is desired to be assigned to the menu, "Off" option must be selected.

15000 recording can be stored in memory on the condition that the total 28 parameters from Pr 1 to Pr 28 are saved as one recording.

At 15001st recording, the first 1000 recordings are cleared automatically. And now, last record will be 14001th recording not 15001th recording.

Note:

Whether parameters are assigned to the menu or not, the memory is separated for 28 parameters and for every record it allocates an area of 28 parameters.

For example:

You can find below how a parameter is assigned to (Pr 12) step by step.

"Pr12" To set the parameter menu, while in the Instantaneous Values menu;

- Press the ENTER button. (The ENERGY menu is displayed)
- Find the "SETUP" menu by scrolling using the UP/DOWN buttons.
- Press the ENTER button. (Network menu is displayed)
- Find the "Datalog" menu by scrolling using the UP/DOWN buttons.
- Press the ENTER button. (Per: menu is displayed)
- Find the "Pr12" menu by scrolling using the UP/DOWN buttons.
- Press the ENTER button
- Enter the "Pr12" parameter by scrolling using the UP/DOWN buttons.
- To record the new "Pr12" parameter, press the ENTER button.

NETWORK ANALYSER

MPR60S / MPR60S-10/20/21/40/41

Per: (Period Menu)

Device records data for desired time periods

"Per" To set time period, while in the Instantaneous Values menu;

- Press the ENTER button. (The ENERGY menu is displayed)
- Find the "SETUP" menu by scrolling using the UP/DOWN buttons.
- Press the ENTER button. (Network menu is displayed)
- Find the "Datalog" menu by scrolling using the UP/DOWN buttons.
- Press the ENTER button. (Per: menu is displayed)
- Press the ENTER button
- Enter "Per" value (Off - 5...32000 sec) by scrolling using the UP/DOWN buttons.
- To record the "Per" val , press the ENTER button.

Note: If "off" is selected record off.

Emergency: Power cuts, switching of one of the output relays, etc.

"Event" To set Event, while in the Instantaneous Values menu;

- Press the ENTER button. (The ENERGY menu is displayed)
- Find the "SETUP" menu by scrolling using the UP/DOWN buttons.
- Press the ENTER button. (Network menu is displayed)
- Find the "Datalog" menu by scrolling using the UP/DOWN buttons.
- Press the ENTER button. (Per: menu is displayed)
- Find the "Event" menu by scrolling using the UP/DOWN buttons.
- Press the ENTER button
- Enter "Event (On-No)" by scrolling using the UP/DOWN buttons.
- To record "Event", Press the ENTER button.

Event (Emergency Recording)

If it is desired to record outside of the adjusted period as well, "Event : On" option should be selected.

PARAMETER TABLE

*V _{L1, L2, L3}	(Phase Voltage)	Imp.(KWh)	(Import Active Energy)	Hr.	(Hour)
*V _{L1, L2, L3, L31}	(Phase-Phase Voltage)	Ind. (KVarh)	(Inductive Reactive Energy)	Min.	(Minute)
*V _k (Average)	(Total Phase Voltage Average)	Cap.(KVarh)	(Capacitive Reactive Energy)	Sec.	(Second)
*V _t (Average)	(Total Phase-Phase Voltages Average)	*THD V% L1, L2, L3	(Total Harmonic Values for Voltages)	Day	(Day)
*Freq. (Hz)	(Frequency)	*THD I% L1, L2, L3	(Total Harmonic Values for Currents)	Mo.	(Month)
*I _{L1, L2, L3}	(Phase Currents)	*Max. VLN	(Maximum Phase Voltages)	Year	(Year)
*ΣI	(Total Phase Currents)	*Min. VLN	(Minimum Phase Voltages)	CTR	(Current Transformer Ratio)
*P _{L1, L2, L3(W)}	(Active Power)	*Max. Demand IL	(Max. Demand of Phase Currents)	VTR	(Voltage Transformer Ratio)
*Q _{L1, L2, L3(VAR)}	(Reactive Power)	*Min. Demand IL	(Min. Demand of Phase Currents)	IOS	(Relay Position)
*S _{L1, L2, L3(VA)}	(Apparent Power)	*Max. Demand ΣI	(Max. Demand of Total Phase Currents)		(Neutral Current)
*ΣP. (W)	(Total Active Power)	*Min. Demand ΣI	(Min. Demand of Total Phase Currents)	Max. Demand ΣW	(Max. Demand of Total Active Powers)
*ΣQ. (VAR)	(Total Reactive Power)	*Demand IL	(Demand of Phase Currents)	Max. Demand ΣVAR	(Max. Demand of Total Reactive Powers)
*ΣS. (VA)	(Total Apparent Power)	*Demand ΣW	(Demand of Total Active Powers)	Max. Demand ΣVA	(Max. Demand of Total Apparent Powers)
*COS _{φL1, L2, L3}	(Displacement Power Factor)	*Demand ΣIL	(Demand of Total Phase Currents)	Min. Demand ΣW	(Min. Demand of Total Active Powers)
*PF _{L1, L2, L3}	(Power Factor)	*Demand ΣW	(Demand of Total Active Powers)	Min. Demand ΣVAR	(Min. Demand of Total Reactive Powers)
ΣP. F	(Total Power Factor)	*Demand ΣVAr	(Demand of Total Reactive Powers)	Min. Demand ΣVA	(Min. Demand of Total Apparent Powers)
Exp.(KWh)	(Export Active Energy)	*Demand ΣVA	(Demand of Total Apparent Powers)		

1. RELAY 1 / 2. RELAY 2

1. Relay 1 and 2. Relay 2 :

Device contains two output relays (NO Normally open). 1.Relay 1 and 2.Relay 2 are used for alarm output. Active relays can be seen on LCD.

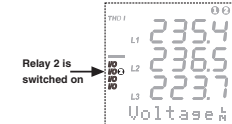
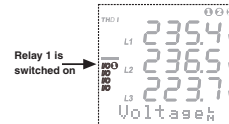

1. Relay 1

3 parameters can be assigned to this output. "Hi" High and "Lo" low value desired for each selected parameter can be adjusted. If the measurement value of any parameter exceeds the setting value, the output relay activates

Relay 1 has 16 sub-menus.

Cfg: By this parameter, relays can be configured as "Alarm Output" (Cfg: Alarm) or as "Digital Output" (Cfg: Dout).

Menu of 1st Parameter

"Pr1:..." , "Hi1:..." , "Lo1:..." , "Hs1:..." , "Dly1:..."

Menu of 2nd Parameter

"Pr2:..." , "Hi2:..." , "Lo2:..." , "Hs2:..." , "Dly2:..."

Menu of 3rd Parameter

"Pr3:..." , "Hi3:..." , "Lo3:..." , "Hs3:..." , "Dly3:..."

NETWORK ANALYSER

MPR60S / MPR60S-10/20/21/40/41

Pr1: (1st Parameter)

This is the menu in which the 1st parameter is assigned to the Relay 1. The parameters that can be set are marked with an * in parameter tables. If no parameter is desired to be assigned to the menu, "Off" option must be selected. **"Pr1" To set Pr1, while in the Instantaneous Values menu;**

- Press the ENTER button. (The ENERGY menu is displayed)
- Find the "SETUP" menu by scrolling using the UP/DOWN buttons.
- Press the ENTER button.(Network menu is displayed)
- Find the "1. Relay1" menu by scrolling using the UP/DOWN buttons.
- Press the ENTER button. (Cfg is displayed)
- Find the "Pr1" menu by scrolling using the UP/DOWN buttons
- Press the ENTER button
- Enter "Pr1" parameter marked with an * in the parameters table by scrolling using the UP/DOWN buttons.
- To record the new "Pr1", press the ENTER button.

Hi1: (Highest value for the 1st parameter)

It is the highest value the 1st parameter is desired to reach. When the measured value is over the adjusted value, Relay 1 activates.

"Hi 1" To set the Hi 1 value, while in the Instantaneous Values menu;

- Press the ENTER button. (The ENERGY menu is displayed)
- Find the "SETUP" menu by scrolling using the UP/DOWN buttons.
- Press the ENTER button.(Network menu is displayed)
- Find the "1. Relay1" menu by scrolling using the UP/DOWN buttons.
- Press the ENTER button. (Cfg is displayed)
- Find the "Hi1" menu by scrolling using the UP/DOWN buttons
- Press the ENTER button
- Enter a "Hi1" value by scrolling using the UP/DOWN buttons. (Hi1 value must be greater than Lo1 value)
- To record "Hi1", press the ENTER button.

Lo1 (Lowest value for the 1st parameter)

It is the lowest value that the 1st parameter is desired to reach. When the measured value is under the adjusted value, Relay 1 activates.

"Lo1" To set the Lo 1 value, while in the Instantaneous Values menu;

- Press the ENTER button. (The ENERGY menu is displayed)
- Find the "SETUP" menu by scrolling using the UP/DOWN buttons.
- Press the ENTER button.(Network menu is displayed)
- Find the "1. Relay1" menu by scrolling using the UP/DOWN buttons
- Press the ENTER button. (Cfg is displayed)
- Find the "Lo1" menu by scrolling using the UP/DOWN buttons

- Press the ENTER button
- Enter a "Lo1" value by scrolling using the UP/DOWN buttons.
- To record "Lo1", press the ENTER button.

Hs1: (Hysteresis value for the 1st parameter)

When the interval is exceeded which is limited with Hi and Lo values, for releasing Relay 1 which is already switched on:

If the warning is caused due to exceeding the Hi value, it is required that the value must decrease as much as Hs (hysteresis) value.

If the warning is caused due to becoming less than the Lo value, it is required that the value must increase as much as Hs (hysteresis) value.

"Hs1" To set the Hs 1 value, while in the Instantaneous Values menu;

- Press the ENTER button. (The ENERGY menu is displayed)
- Find the "SETUP" menu by scrolling using the UP/DOWN buttons.
- Press the ENTER button.(Network menu is displayed)
- Find the "1. Relay1" menu by scrolling using the UP/DOWN buttons.
- Press the ENTER button. (Cfg is displayed)
- Find the "Hs1" Menu by scrolling using the UP/DOWN buttons
- Press the ENTER button
- Enter a "Hs1" value by scrolling using the UP/DOWN buttons.
- To record "Hs1", press the ENTER button.

Dly1: (Delay value for the 1st parameter)

For switching on the Relay 1, value of parameter which is assigned to this output, must exceed determined intervals and this event must continue for a time period which is entered at the Dly1 menu.

To set the Dly 1 value, while in the Instantaneous Values menu;

- Press the ENTER button. (The ENERGY menu is displayed)
- Find the "SETUP" menu by scrolling using the UP/DOWN buttons.
- Press the ENTER button.(Network menu is displayed)
- Find the "1. Relay1" menu by scrolling using the UP/DOWN buttons.
- Press the ENTER button. (Cfg is displayed)
- Find the "Dly1" Menu by scrolling using the UP/DOWN buttons
- Press the ENTER button
- Enter a "Dly1" value by scrolling using the UP/DOWN buttons.
- To record "Dly1", press the ENTER button.

Note:

The 2nd and 3rd parameter settings of Relay 1 such as Hi, Lo, Hs, Dly values can be adjusted like the 1st parameter.

NETWORK ANALYSER

MPR60S / MPR60S-10/20/21/40/41

DIGITAL INPUTS (only for MPR60S-10/20/40)

Digital Inputs

Device has 2 digital inputs. User can monitor the applied voltage to the input on the LCD display.

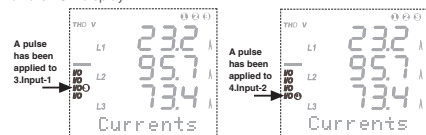

- In order to configure **Input-1** function, in **H 0165** register on communication:
 - "0" has to be entered for Real Time and
 - "1" has to be entered for Latch.
- In order to configure **Input-2** function, in **H 0166** register on communication:
 - "0" has to be entered for Real Time and
 - "1" has to be entered for Latch.

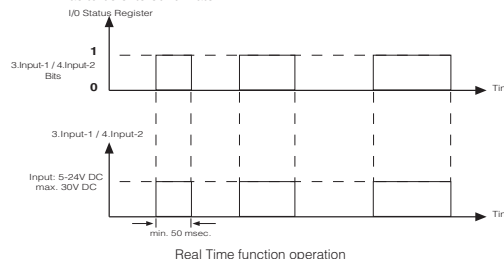

● In order to reset input registers, which are set in latch function, "0" bit has to be written in I/O status register.

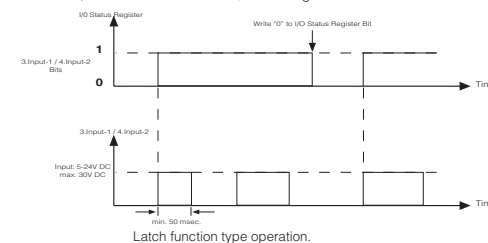

Address: **H 004C**

15	14	13	12	11	10	9	8	7	6	5	4	3	2	1	0
0	0	0	0	0	0	0	0	0	0	0	0	Input2	Input1	Relay2	Relay1

Input 1 and Input 2 register bits show inputs status.

3.INPUT-1/4.INPUT-2 (only for MPR60S-10/20/40)

Fn: Function Setting

- Press the ENTER button. (The ENERGY menu is displayed)
- Find the "SETUP" menu by scrolling using the UP/DOWN buttons.
- Press the ENTER button. (Network menu is displayed)
- Find the "3. Input-1" or "4. Input-2" menu by scrolling using the UP/DOWN buttons.
- Press the ENTER button. (Fn menu is displayed)
- Press the ENTER button.
- Enter a "Fn" value (Real time or Latch) by scrolling using the UP/DOWN buttons.
- To record "Fn", press the ENTER button.

PULSE OUTPUTS (only for MPR60S/MPR60S-21/41)

Pulse Outputs (For Energymeters)

Device has 2 pulse outputs. It is possible to see which one of these outputs generate pulse from the LCD screen at any time.

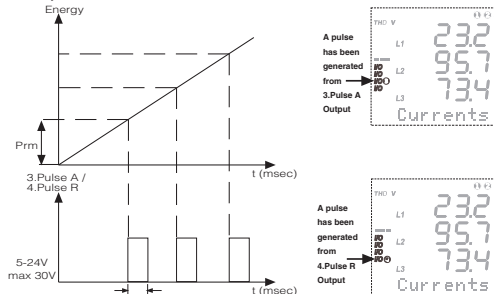

Each time the consumed energy increases by an increment of "Prm", a pulse as long as the "Dur" value entered (msec) is produced in the Pulse Outputs.

3. PULSE A (only for MPR60S/MPR60S-21/41)

3. Pulse A (Import Active Energy Pulse Output)

A pulse is generated in 3. Pulse A proportional to the import active energy value. For example, a pulse for every increase of 10 kWh.

3. Pulse A has 2 sub-menus.

"Prm: ...", "Dur: ..."

Prm: (The Value of the Import Active Energy Value to Set for 1 Pulse)

A pulse is generated from 3. Pulse A output for each increase of the Prm value by a desired amount (1kWh... 50.0 MWh).

Dur: (Pulse Duration in Milliseconds)

A pulse is generated for the desired duration in (100...2500 msec).

- Press the ENTER button. (The ENERGY menu is displayed)
- Find the "SETUP" menu by scrolling using the UP/DOWN buttons.
- Press the ENTER button. (Network menu is displayed)
- Find the "3. Pulse A" menu by scrolling using the UP/DOWN buttons.
- Find Prm / Dur menu by scrolling UP/DOWN buttons. Press ENTER button for selection.
- Enter "Prm value between 1kWh... 50.0 MWh" or "Dur value between 100...2500 msec" by scrolling using the UP/DOWN buttons.
- To record "Prm / Dur", press the ENTER button.

4. PULSE R (only for MPR60S/MPR60S-21/41)

4. Pulse R (Inductive Reactive Energy Pulse Output)

A pulse is generated from 4. Pulse R which is related with inductive value of the reactive energy. For example, one pulse for every increase of 10 kVARh energy.

Pulse-R has 2 sub-menus. **"Prm: ...", "Dur: ..."**

Prm: (The Value of the Inductive Reactive Energy Value to set for 1 Pulse)

A pulse is generated from 4. Pulse R for each increase of the Prm value by a desired amount (1kVARh... 50.0 MVARh).

Dur: (Pulse Duration in Milliseconds)

A pulse is generated for the desired duration in (100...2500 msec).

- Press the ENTER button. (The ENERGY menu is displayed)
- Find the "SETUP" menu by scrolling using the UP/DOWN buttons.
- Press the ENTER button. (Network menu is displayed)
- Find the "4. Pulse R" menu by scrolling using the UP/DOWN buttons.
- Find Prm / Dur menu by scrolling UP/DOWN buttons. Press ENTER button for selection.
- Enter "Prm value between 1kVAR... 50.0 MVARh" or "Dur value between 100...2500 msec" by scrolling using the UP/DOWN buttons.
- To record "Prm / Dur", press the ENTER button.

NETWORK ANALYSER

MPR60S / MPR60S-10/20/21/40/41

DISPLAY

LCD Display Settings

In this menu, LCD display settings are configured. It has 3 sub-menus.

“Loop: ...”, “Cont: ...”, “BL: ...”

Loop:

In this menu, the duration of displaying instantaneous value is adjusted automatically, while in the Instantaneous Values menu. The Loop duration can be adjusted between 1... 600 in terms of seconds.

For example;

The Loop duration is set 10sec. In the Instantaneous Values menu, if any button is not pressed during 10 sec, the Instantaneous values are displayed in sequence for 10 seconds periods.

By using this function all instantaneous values can be observed one after the other without pressing any buttons.

This function can be cancelled by selecting “No” option in the Loop Menu.

INSTANTANEOUS VALUES

Observing the Measured Parameters

In this menu, instantaneous values of parameters are displayed.

This menu is the last menu that is reached by pressing ESC button while in any menu.

Instantaneous values menu is the main menu of device. If you wait a while without pressing any buttons in any menu, the Instantaneous value menu automatically comes back.

When a device is energized for the first time, the device is in the Instantaneous values menu and shows the instantaneous values.

The display is seen as below.

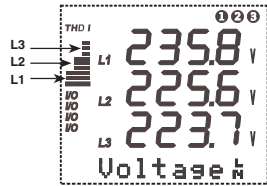

At the bottom of the screen, which sub-menu you are in and the instantaneous values belonging to this menu are displayed. Each bar on the left side of screen shows the ratio between total harmonics amount of current or voltage for one phase to current or voltage in network frequency as a percentage value. Each step shows 10%. It is possible to switch between “THD V” and “THD I” by pressing ESC button. Also, it is possible to see the numerical values of the THD values by going into the Instantaneous Values Menu.

THD V : Total Harmonic Distortion of Voltage

THD I : Total Harmonic Distortion of Current

By scrolling with Δ (UP), ∇ (DOWN) buttons while in the Instantaneous Values Menu, you can observe the below parameters of the network one after the other.

Voltage \downarrow	Voltage \uparrow	Currents	P. Factor	Co ϕ	Active (W)
Reactive (VAR)	Apparent (VA)	Σ Powers	Σ P.F.	THD V %	THD I %
Freq. (Hz)	Average \downarrow	Average \uparrow	Σ Current	Neutral Current (In)	

Note : If there is a “-” symbol before the measured active power, it shows the existence of active export power

Note :

When ARON connection is choosed, “L2 - - -” symbol is seen at the **Currents**, **P.Factor**, **Co ϕ** , **Active**, **Reactive**, **Apparent**, **THD I**, **Har. I**, **DEMAND**, **max.IL**, **DEMAND min.IL**, **DEMAND IL** menus.

Note: When device's phase voltages exceed 330.0 V, phase-phase voltages exceed 530.0 V, phase currents exceed 5.500 A according to upper limits of measurement, “HIGH” is displayed on display.

ENERGY

Observing The Energy Values:

In this menu, energy values are displayed and cleared. In this menu, energy values can be observed which are listed below.

Exp. Export Active Energy **Imp.** Import Active Energy

\sim Inductive Reactive Energy \sim Capacitive Reactive Energy values

These energy values can be cleared one by one or all at once.

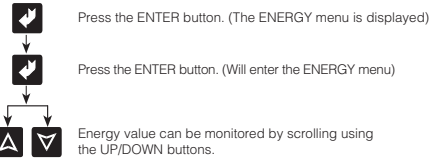

DEMAND

“DEMAND” To see the DEMAND Menu; While in the Instantaneous Values Menu,

Demand : It shows the averages which arise on power and current during demand time.

min. value : It shows the min. value different from zero that measured on voltages.

max. value : It shows the max. value that measured on voltages.

This is the menu in which it is possible to observe the below values;

***max. VL-w** (Max. voltages between Phase-Neutral)

***min. VL-n** (Min. voltages between Phase-Neutral)

***max. Demand IL** (Max. demand values of phase currents)

***min. Demand IL** (Min. demand values of phase currents)

***Demand IL** (Demand values of phase currents)

***max. Demand Σ I and min. Demand Σ I** (Total max. and min. demand values of phase current)

***Demand Σ I** (Demand value of total phase current)

***Demand Σ P, Demand Σ Q and Demand Σ S** (Demand values of total power values)

max. Demand Σ P, max. Demand Σ Q and max. Demand Σ S (Max. demand values of total powers)

min. Demand Σ P, min. Demand Σ Q and min. Demand Σ S (Min. demand values of total powers)

Observed minimum, maximum and demand values can be cleared one by one or all at once.

ANALOG OUTPUT (only for MPR60S-20/21/40/41)

Current and Voltage Analog Output:

In device, this feature gives the possibility that observing the measured values by other devices with converting these values in to 0/4-20 mA (only for MPR60S-40 and MPR60S-41) current data or 0/2-10 V (only for MPR60S-20 and MPR60S-21) voltage data.

The below parameters can be set as analog output :

VL1, L2, L3 (V) (Phase Voltage)	PL1, L2, L3 (W) (Active Power)
VL12, L23, L31 (V) (Phase-Phase Voltage)	QL1, L2, L3 (VAR) (Reactive Power)
V \downarrow (Average) (Average of the total phase voltages)	SL1, L2, L3 (VA) (Apparent Power)
V \uparrow (Average) (Average of the total phase-phase voltages)	Σ I, (A) (Total Phase Currents)
Frequency (Hz) (Frequency)	Σ P, (W) (Total Active Power)
IL1, L2, L3 (A) (Phase Currents)	Σ Q, (VAR) (Total Reactive Power)
THD %VL1, L2, L3 (Total Harmonic Values for Voltages)	Σ S, (VA) (Total Apparent Power)
THD %I1, L2, L3 (Total Harmonic Values for Currents)	

For example (only for MPR60S-40 and MPR60S-41);

Below settings should be fulfilled as like :

Type : 0-20 mA

Prm (Parameter) : VL1

Lo (Low value) : 0 V

Hi (High value) : 300 V

After above settings completed;

Analog current output's value will be 0 mA when VL1 value is 0V,

Analog current output's value will be 20 mA when VL1 value is 300V.

When VL1 is 220 V analog current output value will be;

$$I_{out} = \frac{(20-0) \times (220-0)}{(300-0)} = 14,67 \text{ mA}$$

For example (only for MPR60S-20 and MPR60S-21);

Below settings should be fulfilled as like :

Type : 2-10 V

Prm (Parameter) : L1

Lo (Low value) : 100 mA

Hi (High value) : 5 A

After above settings completed;

Analog voltage output's value will be 2 V when L1 value is 100 mA,

Analog voltage output's value will be 10 V when L1 value is 5 A.

When L1 is 3.5 A analog voltage output value will be;

$$I_{out} = \frac{(10-2) \times (3.5-0.1)}{(5-0.1)} = 2 = 7.551 \text{ V}$$

for example (only for MPR60S-40 and MPR60S-41);

Below settings should be fulfilled as like.

Type : 0-20 mA

Prm (Parameter) : PL1

Lo (Low value) : -650 W

Hi (High value) : 350 W

After above settings completed;

Analog current output's value will be 0 mA when PL1 value is -650 W,

Analog current output's value will be 20 mA when PL1 value is 350 W.

When PL1 is -300 W analog current output value will be;

$$I_{out} = \frac{(20-0) \times [(-300)-(-650)]}{(350-(-650))} = 7 \text{ mA}$$

NETWORK ANALYSER

MPR60S / MPR60S-10/20/21/40/41

INFO

INFO: In this menu, the information about the memory of the device and the producer are obtained.

Information menu has three sub-menus.

Log.Rec..... Eng. Rec..... Producer-Production Information.....

PASSWORD

Password Menu : (Menu for setting up a user password)

In this menu, a user password is set and activated. In order to prevent the device's SETUP, DEMAND and ENERGY menus from unauthorized access, it is necessary to set up a 3 digit user password and then activate it.

Set Psw: (Menu for setting up a user password)

Press the ENTER button (The ENERGY menu is displayed.)

Find the “SETUP” Menu scrolling UP/DOWN buttons.

Press the ENTER button (The Network menu is displayed.)

Find the “Set Psw” menu by scrolling using the UP/DOWN buttons.

Press the ENTER button. “New 000” is displayed.

Enter the new 3 digit password by using the UP/DOWN and ENTER buttons. (Don't enter the new password as 000)

Press the ENTER button. The Chg Psw menu is displayed. (For cancel the password enter as Chg Psw: 000). The new pasword is saved to the SETUP, DEMAND and ENERGY menus.

You can press the ESC button to return to instantaneous values menu.

Chg Psw: (Menu for changing user password)

Press the ENTER button (The ENERGY menu is displayed.)

Find the “SETUP” Menu scrolling UP/DOWN buttons. “SETUP \downarrow ” menu is displayed.

Press the ENTER button (Psw: 000 is displayed.)

Enter the old 3 digit password using the UP/DOWN and ENTER buttons (ie Psw:999).

Press the ENTER button (Network menu is displayed.)

Find the “Chg Psw” menu by scrolling using the UP/DOWN buttons.

Press the ENTER button, previous password (ie New: 999) is displayed

Enter the new 3 digit password by using the UP/DOWN and ENTER buttons. (Don't enter the new password as 000)

Press the ENTER button. The Chg Psw menu is displayed. (For cancel the password enter as Chg Psw: 000). The new pasword is saved to the SETUP, DEMAND and ENERGY menus.

You can press the ESC button to return to instantaneous values menu.

FRONT PANEL PROPERTIES

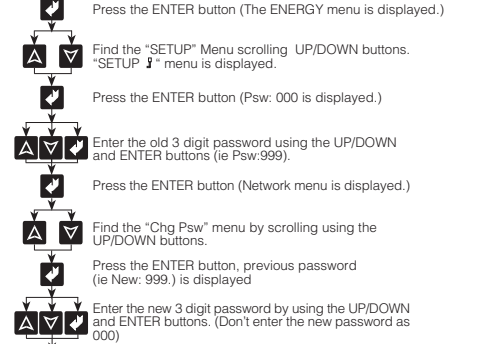

- Menu (ENTER) button.
- Down button.
- Up button.
- ESC button. It is used to exit from a menu. (THD I and THD V menus are choosed)
- Menu and Energy line. Shows the present menu. It also shows the energy values.
- Shows whether the value in the Energy Menu is Export, Import, Inductive or Conductive.
- Shows which Output is active.
- Harmonic bars. The total harmonics of the 3 phases are displayed graphically. The columns represents L1, L2 and L3 phases. Each step shows as percentage scale of 10%. V represents the voltages' harmonics and I represents the currents' harmonics.
- Shows which phase / phase - phase that the measured parameter belongs to.
- Expresses the CO ϕ or PF (Power Factor) value of the related phase.
- Shows the direction of the value for the related phase. Capacitive or Inductive. (PF, CO ϕ and Reactive Power light up while measuring.)
- Min. and Max. symbols. They light up in the Demand menu.
- Harmonic symbols. Means that harmonics are displayed on the screen.
- Total symbol. Shows the total value of the related parameter.
- Phase sequence failure
- Demand symbol. Shows the demand value of the related parameter.
- PC Communication symbols. Shows the existence of communication on the connection line.
- Phase existence symbols.
- Display lines for the measured parameters and their units. (V, kV, MV, A, kA, MA, W, kW, MW, VA, kVA, MVA, VAR, kVAR, MVAR)
- 3.6" LCD Display
- Backlight
- Shows the units of the measured energy values (kWh, kVAh, MWh, MVAh)

CE A2922/Rev.6 ver. 1.78